



# F-427i

## BIOMEDICAL FREEZER

Our upright design is a great choice when you need a storage solution for larger quantities.



-5°C  
-25°C

### DIMENSIONS

Outer Dimensions HxWxD, mm	2002x595x642
Inner Dimensions HxWxD, mm	1827x475x495
Weight Gross/Net, kg	100 / 86
Material inner cabinet	ABS
Material outer cabinet	Painted Steel
Packaging weight, kg	14
Packaging dimensions HxWxD, mm	2218x710x650
Insulation thickness	50
Insulation type	Polyurethane with Cyclopentane
Air distribution	Dynamic
Mobility	Standard: Adjustable Feet - Option: Castors
Refrigerant, Type / gram	R290 / 80
Variable Speed Compressor	Yes - Adaptive Cooling Technology
Number of probes	2

### CONTROLLER

Controller	i-Care, Touch screen
Controller language	EN, DE, FR
USB Connection	Yes
Logging	Data, Alarms & Events
Temperature graph	Yes
High/Low temp. Alarm	Yes
Open door alarm	Yes
Probe failure alarm	Yes
Power failure alarm	Yes

### STORAGE

Volume, Gross/Net, L	427 / 361
Shelves, Full/Half	5 / 1
Shelf material	Perforated Alu

### FEATURES

Lock	Yes
LED light	Yes
Battery Backup for Controller, 24h	Yes
No-Frost System™	Yes
Door frame heater	Hot gas
Porthole	Yes - Ø 20 mm
Dry Contact	Yes
Door	Standard: Solid
Door Features	Automatic: Closure < 90° - Hold Closure > 90°
Door Reversibility	Yes



# F-427i

## BIOMEDICAL FREEZER

Our upright design is a great choice when you need a storage solution for larger quantities.

<b>Voltage/Frequency</b>	Voltage/Hz	230V/50-60Hz
<b>Max Ambient</b>	°C	30°C
<b>Max Humidity</b>	% rh	65%
<b>PERFORMANCE</b>		
All data in RT20°C		
<b>Temperature Range</b>	°C	-5 to -25
<b>Uniformity in performance - difference between top and bottom</b>	°C	+/- 3.0
<b>Pull down time</b>	Minutes	110 min to -20°C
<b>Hold over time</b>	Minutes	72 min to -10°C
<b>Noise</b>	dB	50
<b>Energy Saving Mode</b>	kWh/24h	3,181kWh/24h Set -20
<b>Energy Consumption, kWh / 24h</b>	kWh/24h	3,773kWh/24h Set -25
<b>Energy year</b>	kWh/year	1377kWh/y Set -25°
<b>Instant Power Consumption</b>	kW	PD 0,220/Stable 0,150
<b>Heat Rejection</b>	W	260
<b>U-Value</b>	W/m <sup>2</sup> K	0.44
<b>COOLING COMPONENTS</b>		
<b>Refrigerant/Amount (gram)</b>		R290/80gr
<b>Number of compressors</b>	pcs	1
<b>Variable speed compressor</b>	Yes/No	Yes
<b>Internal air distribution (type of)</b>		Triple Air Stream
<b>Evaporator Fan</b>	Yes/No/Variable	Yes
<b>Condenser Fan</b>	Yes/No/Variable	Yes
<b>Number of probes</b>	pcs	2
<b>Defrost</b>	Yes/No	Yes - automatic
<b>FEATURES</b>		
<b>Safety thermostat</b>	y/n/optional	No
<b>Lock</b>	y/n	Yes
<b>LED light</b>	y/n	Yes
<b>Battery Back Up For Controller</b>	y/n/optional	Yes - 24h
<b>Porthole</b>	y/n - Ømm	Yes - Ø 20mm
<b>Dry contact</b>	y/n	Yes
<b>Castors</b>	y/n/optional	Optional
<b>Door</b>	glass/solid	Solid
<b>Door closure</b>	y/n/optional	Yes
<b>Door reversibility</b>	y/n	Yes
<b>Automatic Hold 90°C</b>	y/n	Yes
<b>Vacuum valve</b>	y/n	Yes
<b>VIP (Vacum panel)</b>	y/n	No
<b>Perimeter heater</b>		Hot gas loop



# F-427i

## BIOMEDICAL FREEZER

Our upright design is a great choice when you need a storage solution for larger quantities.

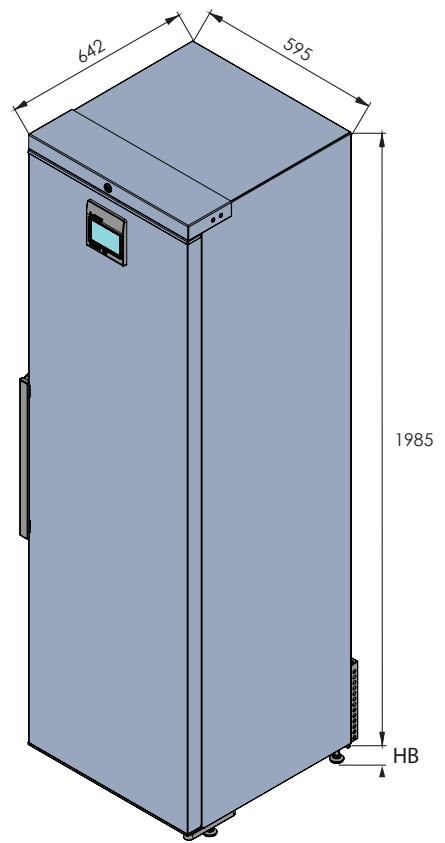
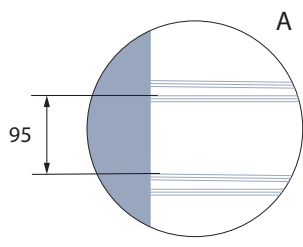
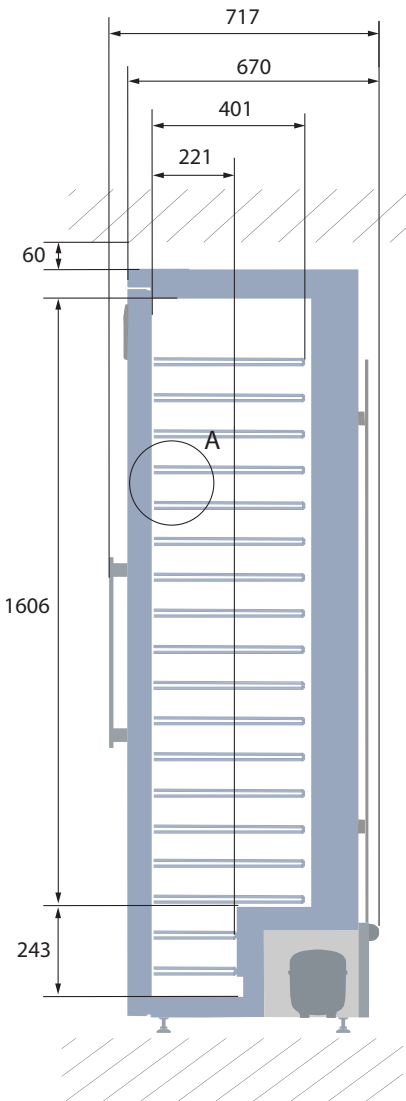
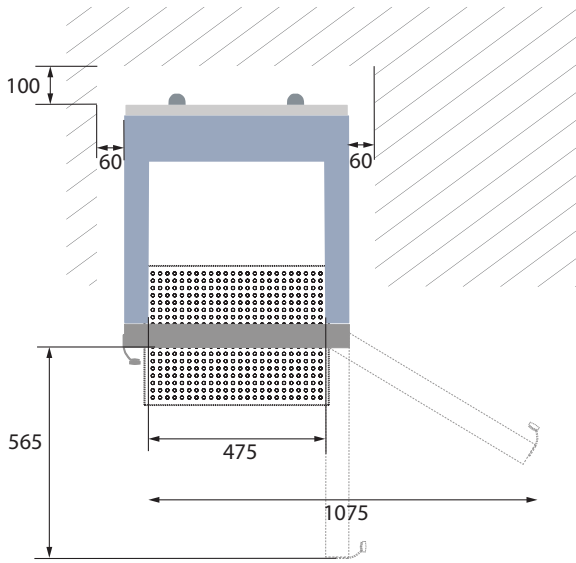

All measurements in mm.

HB: Height of base  
(HB is adjustable when given value is xx-xx)

69   
Wheel

20-58   
Adjustable foot



# F-427i

## BIOMEDICAL FREEZER

Our upright design is a great choice when you need a storage solution for larger quantities.

BIOMEDICAL

SENSOR POSITION		MODEL	F-427i
<p><b>FRONT VIEW</b></p> <p><b>TOP VIEW</b></p>		<b>Test type</b> <b>Test environment</b> <b>Ambient temperature</b> <b>Humidity</b> <b>Set-point</b> <b>Sensor used</b> <b>Installation</b> <b>Refrigerant</b>	15-point test Controlled conditions, empty cabinet 20°C 60% -25°C 25gr tinned brass formed as a cylinder with a diameter of 15,2 mm Appliance installed according to instruction manual conditions R600a

SENSOR TEMPERATURE															
Sensor position	P1	P2	P3	P4	P5	P6	P7	P8	P9	P10	P11	P12	P13	P14	P15
Max	-22	-22,4	-22,9	-21,5	-22,6	-22,4	-23,5	-23,5	-22,4	-23,4	-22,6	-23,5	-23,6	-22,5	-23,5
Avg.	-22,9	-23,3	-24,1	-22,2	-23,2	-23,4	-24,3	-24,3	-23,5	-24,4	-23,6	-24,6	-24,7	-23,3	-24,6
Min.	-24	-24,6	-25,3	-23,1	-24	-24,6	-25,2	-25,3	-24,8	-25,5	-24,8	-25,9	-25,9	-24,4	-26

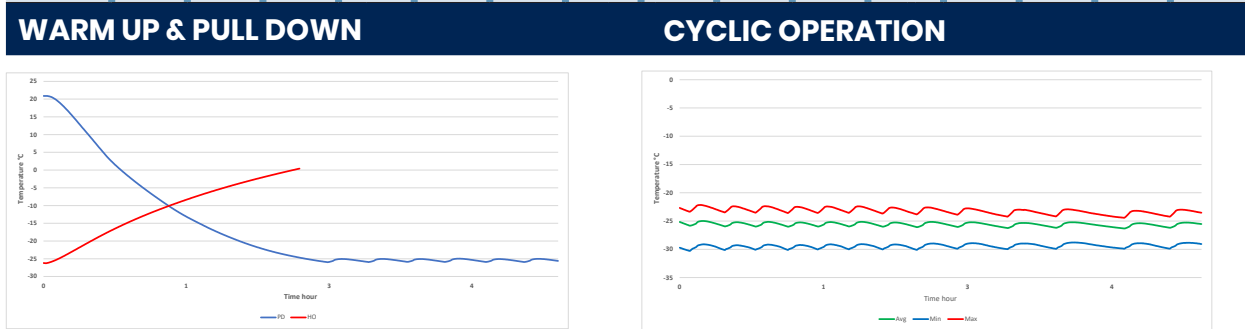

TYPICAL PERFORMANCE IN AMBIENT 20°C – EMPTY CABINET	
Avg. cabinet temperature	-25,6°C
Uniformity	+/- 3,0°C
Stability in avg.	0,6°C
1 min. door open recovery to -20°C avg. temperature	15 min.
Cycle rate on/off	19 / 3 min.
Duty cycle	84%
Energy consumption - Normal mode	3,7 kWh/day
Energy consumption - Energy saving mode (-20)	3,1 kWh/day
Pull down time to -20°C avg. temperature	110 min.
Hold over time from -25°C to -10°C	72 min.
Sample temperature does not exceed	-15°C
Heat rejection	260