



BIOMEDICAL

R-427i Glass

BIOMEDICAL REFRIGERATOR

Our upright design is a great choice when you need a storage solution for larger quantities.



+2°C
+20°C

DIMENSIONS

Outer Dimensions HxWxD, mm	2002x595x642
Inner Dimensions HxWxD, mm	1827x475x495
Weight Gross/Net, kg	100 / 86
Material inner cabinet	ABS
Material outer cabinet	Painted Steel
Packaging weight, kg	14
Packaging dimensions HxWxD, mm	2218x710x650
Insulation thickness	50
Insulation type	Polyurethane with Cyclopentane
Air distribution	Dynamic
Mobility	Standard: Adjustable Feet - Option: Castors
Refrigerant, Type / gram	R600a / 60
Variable Speed Compressor	Yes - Adaptive Cooling Technology
Number of probes	4

CONTROLLER

Controller	i-Care, Touch screen
Controller language	EN, DE, FR
USB Connection	Yes
Logging	Data, Alarms & Events
Temperature graph	Yes
High/Low temp. Alarm	Yes
Open door alarm	Yes
Probe failure alarm	Yes
Power failure alarm	Yes

STORAGE

Volume, Gross/Net, L	427 / 361
Shelves, Full/Half	5 / 1
Shelf material	Perforated Alu

FEATURES

Lock	Yes
LED light	Yes
Battery Backup for Controller, 24h	Yes
Safety thermostat	Yes
Porthole	Yes - Ø 20 mm
Dry Contact	Yes
Reference bottle	Yes
Door	Glass
Door Features	Automatic: Closure < 90° - Hold Closure > 90°
Door Reversibility	Yes



R-427i Glass

BIOMEDICAL REFRIGERATOR

Our upright design is a great choice when you need a storage solution for larger quantities.

Voltage/Frequency	Voltage/Hz	230V/50-60Hz
Max Ambient	°C	32°C
Max Humidity	% rh	65%
PERFORMANCE		
All data in RT20°C		
Temperature Range	°C	2 to 20
Uniformity in performance - difference between top and bottom	°C	+/- 1,6
Pull down time	Minutes	66 min to 6°C
Hold over time	Minutes	80 min to 10°C
Noise	dB	40
Energy Consumption, kWh / 24h	kWh/24h	0,499kWh/24h set 5°C
Energy year	kWh/year	182kWh/y set 5°C
Instant Power Consumption	kW	PD 0,08/Stable 0,025
Heat Rejection	W	83
U-Value	W/m ² K	0,7
COOLING COMPONENTS		
Refrigerant/Amount (gram)		R600a/60gr
Number of compressors	pcs	1
Variable speed compressor	Yes/No	Yes
Internal air distribution (type of)		Dual Air Stream
Evaporator Fan	Yes/No/Variable	Yes
Condenser Fan	Yes/No/Variable	No
Number of probes	pcs	4
Defrost	Yes/No	Yes - automatic
FEATURES		
Safety thermostat	y/n/optional	Yes
Lock	y/n	Yes
LED light	y/n	Yes
Battery Back Up For Controller	y/n/optional	Yes - 24h
Porthole	y/n - Ømm	Yes - Ø 20mm
Dry contact	y/n	Yes
Castors	y/n/optional	Optional
Door	glass/solid	Glass
Reference bottle	y/n/optional	Yes
Door closure	y/n/optional	Yes
Door reversibility	y/n	Yes
Automatic Hold 90°C	y/n	Yes
Vacum ventil + VIP (Vacum panel)	y/n	No



R-427i Glass

BIOMEDICAL REFRIGERATOR

Our upright design is a great choice when you need a storage solution for larger quantities.

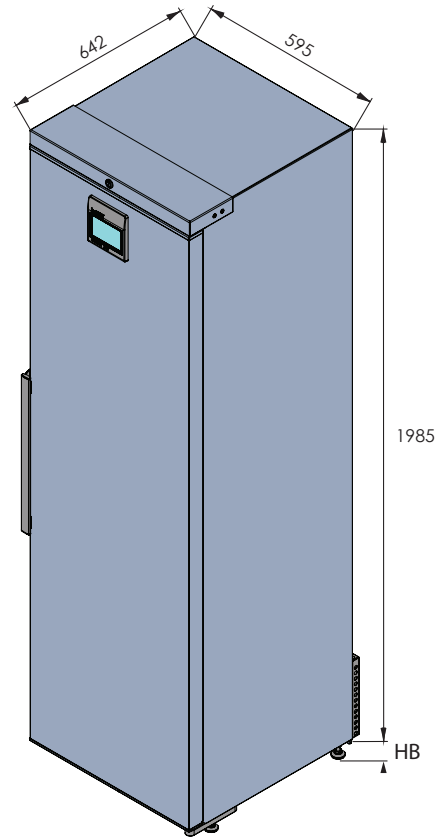
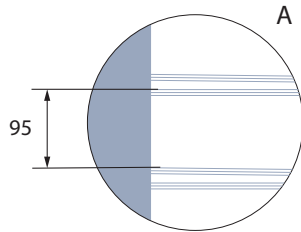
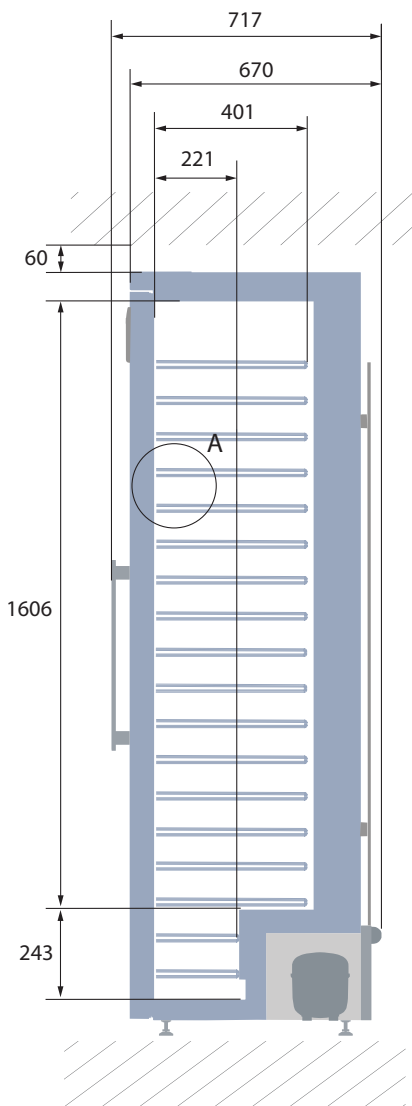
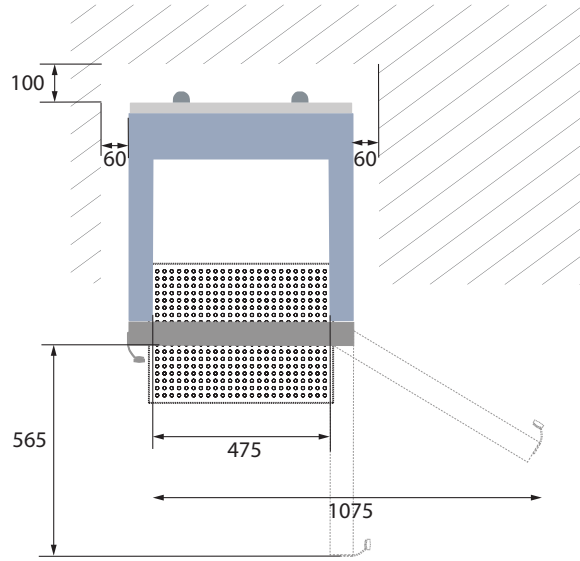

All measurements in mm.

HB: Height of base
(HB is adjustable when given value is xx-xx)

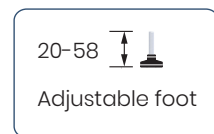
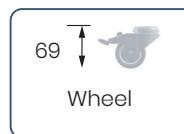



R-427i Glass

BIOMEDICAL REFRIGERATOR

Our upright design is a great choice when you need a storage solution for larger quantities.

SENSOR POSITION		MODEL	R-427i GLASS
<p>FRONT VIEW</p> <p>TOP VIEW</p>		<p>Test type</p> <p>15-point test</p> <p>Test environment</p> <p>Controlled conditions, empty cabinet</p> <p>Ambient temperature</p> <p>20°C</p> <p>Humidity</p> <p>60%</p> <p>Set-point</p> <p>5°C</p> <p>Sensor used</p> <p>25gr tinned brass formed as a cylinder with a diameter of 15,2 mm</p> <p>Installation</p> <p>Appliance installed according to instruction manual conditions</p> <p>Refrigerant</p> <p>R600a</p>	

SENSOR TEMPERATURE															
Sensor position	P1	P2	P3	P4	P5	P6	P7	P8	P9	P10	P11	P12	P13	P14	P15
Max.	4,1	4,5	4,8	5,2	4,3	3,6	3,6	4,5	4,4	3,7	6,4	6,1	6,2	6,2	6,2
Avg.	3,7	4,1	4,5	5	3,8	3,1	3,5	4,1	4	3,1	6,2	6	6,1	6,1	6
Min.	3,4	3,8	4,2	4,8	3,4	2,7	3	3,9	3,7	2,7	6,1	5,9	6	6	5,9

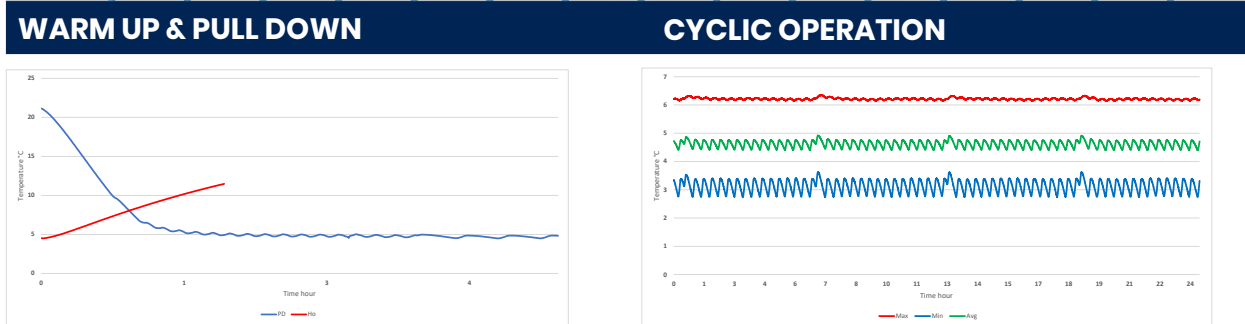

TYPICAL PERFORMANCE IN AMBIENT 20°C – EMPTY CABINET	
Avg. cabinet temperature	4,6°C
Uniformity	+/- 1,6°C
Stability in avg.	0,5°C
1 min. door open recovery to 6°C avg. temperature	<1 min.
Cycle rate on/off	16,9 / 5,3 min.
Duty cycle	76%
Energy consumption	0,499 kWh/day
Pull down time to 6°C avg. temperature	66 min.
Hold over time from 5°C to 10°C	80 min.
Sample temperature does not exceed	8°C
Heat rejection	83 W