



BIOMEDICAL

# F-138i

## BIOMEDICAL FREEZER

With a compact design, this undercounter fits perfectly beneath your work bench, providing a storage solution that is ideal for places where space is limited.



DIMENSIONS	
Outer Dimensions HxWxD, mm	825x595x642
Inner Dimensions HxWxD, mm	676x475x495
Weight Gross/Net, kg	60 / 49
Material inner cabinet	ABS
Material outer cabinet	Painted Steel
Packaging weight, kg	11
Packaging dimensions HxWxD, mm	1037x710x650
Insulation thickness	50
Insulation type	Polyurethane with Cyclopentane
Air distribution	Dynamic
Mobility	Standard: Adjustable Feet - Option: Castors
Refrigerant, Type / gram	R600a / 43
Variable Speed Compressor	Yes - Adaptive Cooling Technology
Number of probes	2
CONTROLLER	
Controller	i-Care, Touch screen
Controller language	EN, DE, FR
USB Connection	Yes
Logging	Data, Alarms & Events
Temperature graph	Yes
High/Low temp. Alarm	Yes
Open door alarm	Yes
Probe failure alarm	Yes
Power failure alarm	Yes
STORAGE	
Volume, Gross/Net, L	138 / 117
Shelves, Full/Half	2 / 1
Shelf material	Perforated Alu
FEATURES	
Lock	Yes
LED light	Yes
Battery Backup for Controller, 24h	Yes
No-Frost System™	Yes
Door frame heater	Hot gas
Porthole	Yes - Ø 20 mm
Dry Contact	Yes
Door	Standard: Solid
Door Features	Automatic: Closure < 90° - Hold Closure > 90°
Door Reversibility	Yes



# F-138i

## BIOMEDICAL FREEZER

With a compact design, this undercounter fits perfectly beneath your work bench, providing a storage solution that is ideal for places where space is limited.

<b>Voltage/Frequency</b>	Voltage/Hz	230V/50-60Hz
<b>Max Ambient</b>	°C	35°C
<b>Max Humidity</b>	% rh	65%
<b>PERFORMANCE</b>		
All data in RT20°C		
<b>Temperature Range</b>	°C	-5 to -25
<b>Uniformity in performance - difference between top and bottom</b>	°C	+/- 1.4
<b>Pull down time</b>	Minutes	70 min to -20°C
<b>Hold over time</b>	Minutes	61 min to -10°C
<b>Noise</b>	dB	45
<b>Energy Saving Mode</b>	kWh/24h	1,147 kWh/24h Set -20
<b>Energy Consumption, kWh / 24h</b>	kWh/24h	1,419 kWh/24h Set -25
<b>Energy year</b>	kWh/year	518 kWh/y Set -25°
<b>Instant Power Consumption</b>	kW	PD 0,120/Stable 0,052
<b>Heat Rejection</b>	W	120
<b>U-Value</b>	W/m <sup>2</sup> K	0.59
<b>COOLING COMPONENTS</b>		
<b>Refrigerant/Amount (gram)</b>		R600a/43gr
<b>Number of compressors</b>	pcs	1
<b>Variable speed compressor</b>	Yes/No	Yes
<b>Internal air distribution (type of)</b>		Dual Air Stream
<b>Evaporator Fan</b>	Yes/No/Variable	Yes
<b>Condenser Fan</b>	Yes/No/Variable	No
<b>Number of probes</b>	pcs	2
<b>Defrost</b>	Yes/No	Yes - automatic
<b>FEATURES</b>		
<b>Safety thermostat</b>	y/n/optional	No
<b>Lock</b>	y/n	Yes
<b>LED light</b>	y/n	Yes
<b>Battery Back Up For Controller</b>	y/n/optional	Yes - 24h
<b>Porthole</b>	y/n - Ømm	Yes - Ø 20mm
<b>Dry contact</b>	y/n	Yes
<b>Castors</b>	y/n/optional	Optional
<b>Door</b>	glass/solid	Solid
<b>Door closure</b>	y/n/optional	Yes
<b>Door reversibility</b>	y/n	Yes
<b>Automatic Hold 90°C</b>	y/n	Yes
<b>Vacuum valve</b>	y/n	Yes
<b>VIP (Vacum panel)</b>	y/n	No
<b>Perimeter heater</b>		Hot gas loop



# F-138i

## BIOMEDICAL FREEZER

With a compact design, this undercounter fits perfectly beneath your work bench, providing a storage solution that is ideal for places where space is limited.

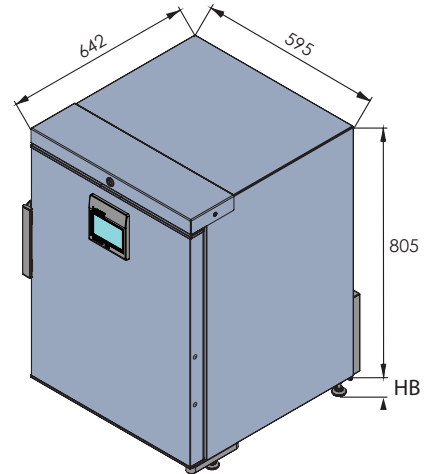
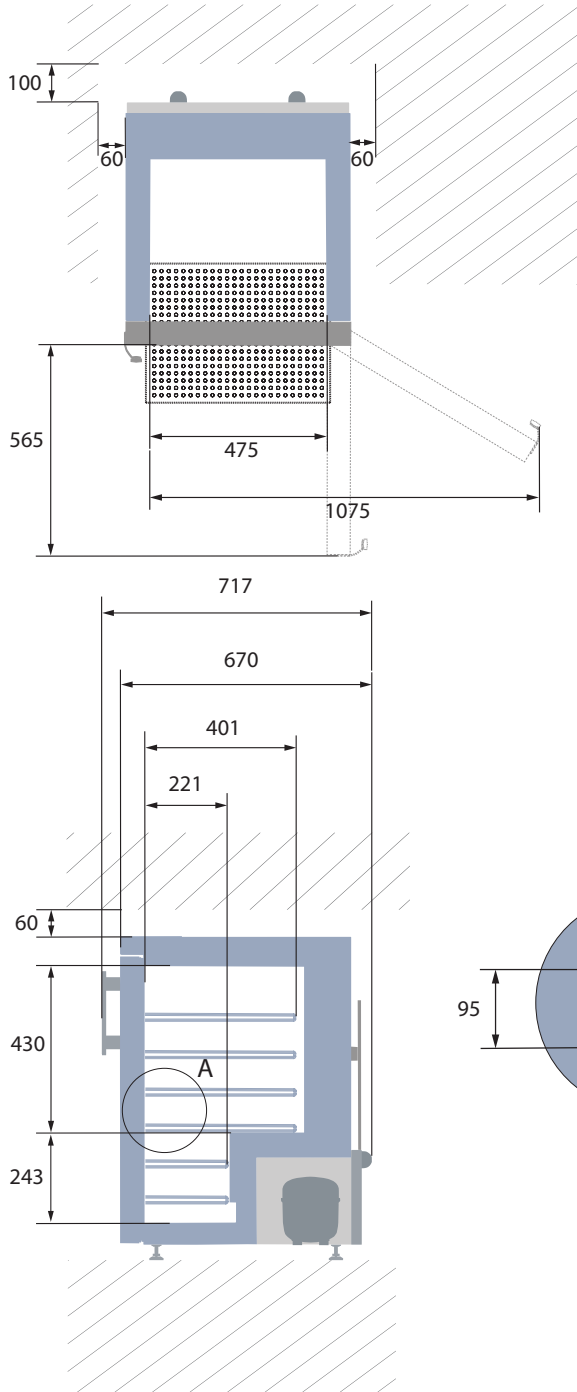

All measurements in mm.

HB: Height of base  
(HB is adjustable when given value is xx-xx)

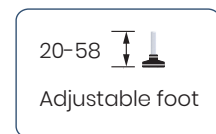
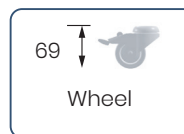

## SENSOR POSITION

FRONT VIEW

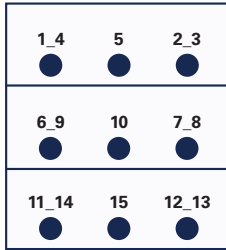

TOP VIEW

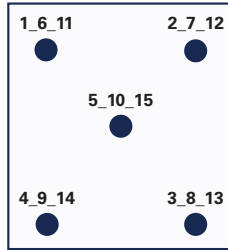

## MODEL

**F-138I**

Test type	15-point test
Test environment	Controlled conditions, empty cabinet
Ambient temperature	20°C
Humidity	60%
Set-point	-25°C
Sensor used	25gr tinned brass formed as a cylinder with a diameter of 15,2 mm
Installation	Appliance installed according to instruction manual conditions
Refrigerant	R600a

## SENSOR TEMPERATURE

Sensor position	P1	P2	P3	P4	P5	P6	P7	P8	P9	P10	P11	P12	P13	P14	P15
Max	-22,9	-22,9	-23,1	-22,5	-23,1	-24	-24,7	-24,4	-23,4	-24,4	-23,7	-25,4	-24,7	-24	-25,2
Avg.	-23,5	-23,4	-23,7	-23	-23,6	-24,5	-25,2	-24,8	-23,9	-24,9	-24,1	-25,9	-25,2	-24,4	-25,7
Min.	-24,1	-24	-24,2	-23,5	-24,1	-24,9	-25,6	-25,3	-24,3	-25,3	-24,5	-26,4	-25,7	-24,9	-26,2

## WARM UP & PULL DOWN

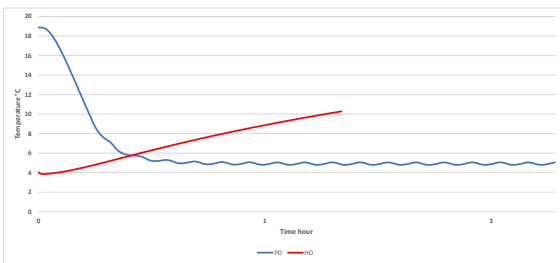

## CYCLIC OPERATION

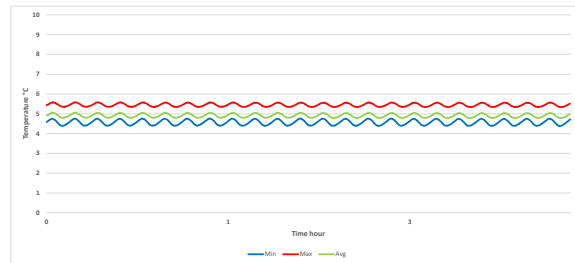

## TYPICAL PERFORMANCE IN AMBIENT 20°C - EMPTY CABINET

Avg. cabinet temperature	-24,4°C
Uniformity	+/- 1,4°C
Stability in avg.	0,3°C
1 min. door open recovery to -20°C avg. temperature	11 min.
Cycle rate on/off	29 / 2 min.
Duty cycle	92,6%
Energy consumption - Normal mode	1,419 kWh/day
Energy consumption - Energy saving mode (-20)	1,147 kWh/day
Pull down time to -20°C avg. temperature	70 min.
Hold over time from -25°C to -10°C	61 min.
Sample temperature does not exceed	-15°C
Heat rejection	120

## 1 MIN DOOR OPENING

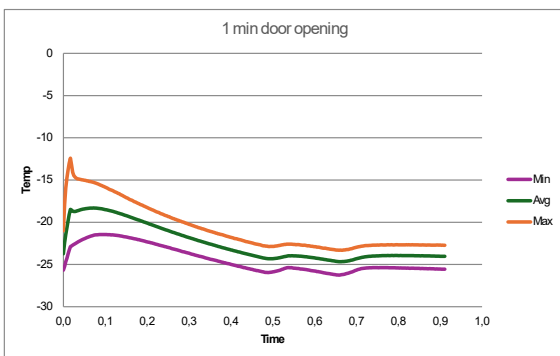

## 24 H STEADY WITH DEFROST SP -25°C

